

Compactors

IHC - Fixed

IHC R - Rotating



IHC and IHC R compactors

Indeco IHC compactors combine high compaction with fast turnaround times. They are a very efficient replacement both for traditional risky and tiring manual equipment and for self-propelled rollers, which are at great risk of rollover during slope applications.

Compaction is achieved by applying both the dynamic force of a hydraulically-driven vibration system and the static weight of the carrier boom to the thick steel baseplate of the compactor.

Of course, the dynamic forces have to be powerful enough to vibrate the steel baseplate. To enable this to happen, Indeco compactors (mounted straight onto the carrier boom) are hydraulically driven with an oil-bath bearing system, which gives a balanced design of compaction force and vibration speed, so as to achieve the depth penetration needed to reduce air voids and move more material faster. Indeco's fixed or rotating IHC hydraulic compactors offer superior efficiency and versatility compared with other products on the market. Being fitted with the same mounting bracket as other Indeco hydraulic equipment makes it easy to switch from one tool to another at the jobsite.

Using just the carrier's hydraulic circuit, they are ideal for compacting backfill for trenches, as well as embankments or other steep slope applications, around foundations or close to other obstacles.

IHC compactors are also perfect for working on grainy, cohesive and semi-cohesive soils with optional adapters on the vibratory plate turning them into highly efficient, pile-driving tools. Indeco's rotating compaction plate, the IHC R, makes it much easier to position the excavator at the right angle to the working surface, especially for jobs in narrow pipe trenches and confined areas, where the compaction plate needs to reach into difficult corners or skirt round manholes and other obstacles.

Robust, versatile and highly productive, IHC compactors have a number of special features created by the technology researchers at Indeco.



Features of Indeco compactors

The system uses oil-bath bearings **|1|**, ensuring maximum reliability, low maintenance costs and high performance, even on the toughest of jobs.

The rubber shock-absorber system **|2|** is designed to direct the whole force down into the material to be compacted, thus isolating vibrations from the carrier and the operator.

The thick chassis and baseplates **|3|** are made from extra-strength steel alloys which means no flexing or other buckling that could affect performance.

The hydraulic system **|4|** balances force and speed to ensure that the eccentric weights can achieve depth penetration and reduce air voids.

The compactor has been specially designed **|5|** to work up close to trench walls, foundations, guard rails and other obstacles, along the whole width and length of the job.

The pressure- and flow-control valve **|6|** provides safer, quicker installation, ensuring that incorrect set-ups cannot affect the long-term reliability of the compactor.

The hydraulic connections **|7|** are located in a practical and functional area in the rear of the compactor.



They run parallel with the carrier hoses, which protects them from accidental breakage, especially in deep narrow pipe trenches.

The motor **|8|**, with its special high-pressure seals, can withstand backpressure without the need for a drain line.

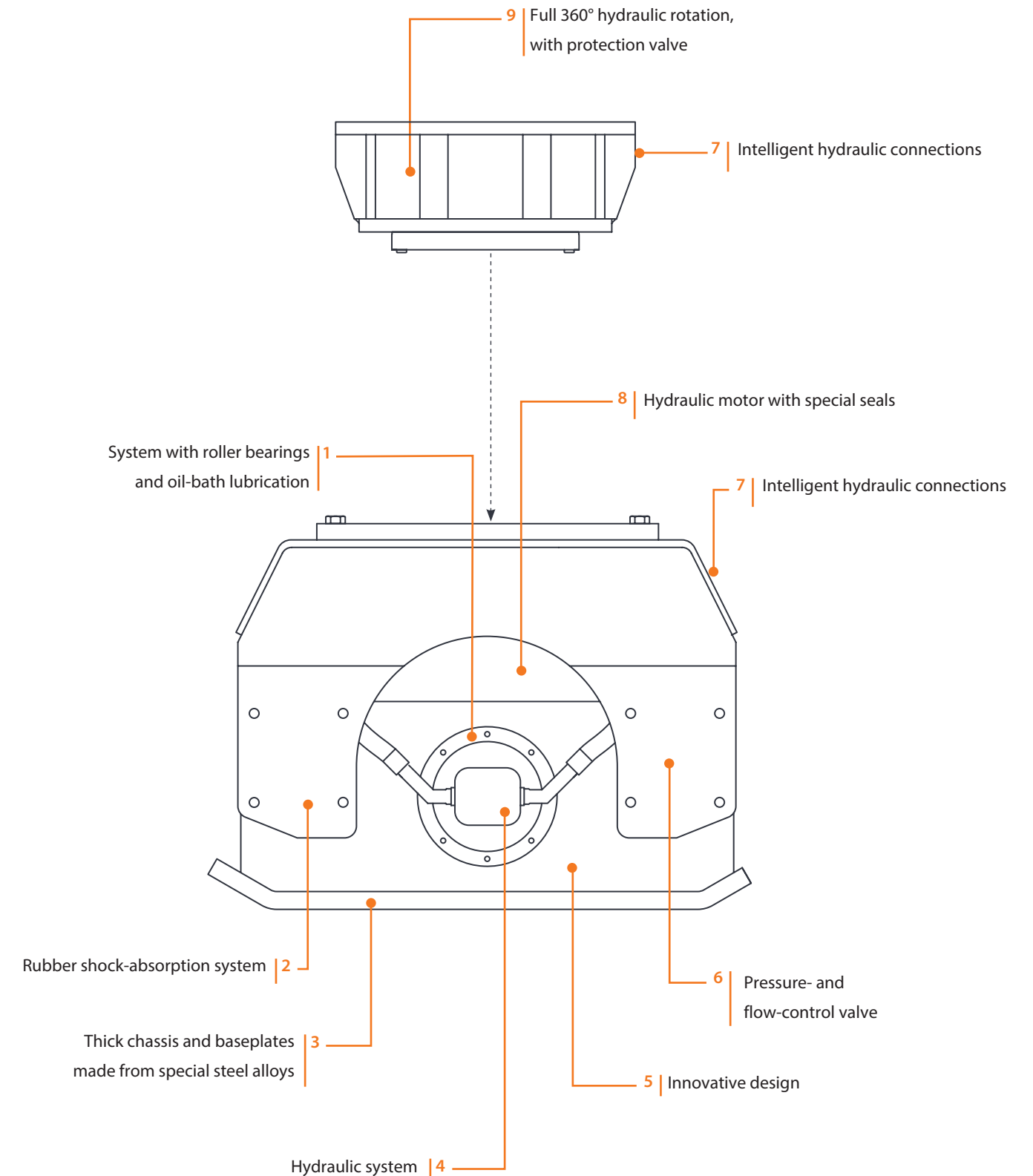
Full 360° hydraulic rotation **|9|** optimizes the position of the vibratory plate under any working conditions, moving more material faster.







Technical Data	IHC 50	IHC 70	IHC 75
Type of carrier	1 3	1 3	1 3
Excavator weight	3800 ÷ 17600 lbs	7700 ÷ 28600 lbs	8800 ÷ 30800 lbs
Equipment weight*	450 lbs	1000 lbs	1100 lbs
Height	22 in	23.5 in	23.5 in
Baseplate size	12 x 30 in	18 x 33 in	25 x 34 in
Centrifugal force	6600 lbs	8800 lbs	8800 lbs
Compacting force Min - Med - Max	10.8 16.9 24.2 psi 	11.7 15.6 20 psi 	9.2 12.2 15.7 psi 
Frequency Min - Med - Max	2000 2500 3000 rpm 33 42 50 hz	1600 1850 2100 rpm 27 31 35 hz	1600 1850 2100 rpm 27 31 35 hz
Oil flow to motor	12 ÷ 18 gpm	15 ÷ 20 gpm	15 ÷ 20 gpm
Maximum working pressure adjusted to the excavator	3450 psi	2850 psi	2850 psi
Maximum backpressure	100 psi	300 psi	300 psi
Compatibility of attachment plate with mounting bracket	HP 550	HP 1250	HP 1250

*The operating weight of the equipment includes mounting bracket compatible with Indeco construction standards. Any differences in weight may be due to a different mounting bracket configuration.

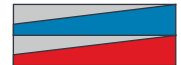

Technical Data	IHC 150	IHC 250
Type of carrier	4 5	4 5
Excavator weight	17600 ÷ 48400 lbs	33000 ÷ 99000 lbs
Equipment weight*	2150 lbs	2850 lbs
Height	31.5 in	31.5 in
Baseplate size	28 x 47 in	35 x 48 in
Centrifugal force	22000 lbs	37400 lbs
Compacting force Min - Med - Max	18.9 22.1 25.6 psi 	17.7 24 31.3 psi 
Frequency Min - Med - Max	1800 1950 2100 rpm 30 33 35 hz	1800 2100 2400 rpm 30 35 40 hz
Oil flow to motor	27 ÷ 32 gpm	50 ÷ 70 gpm
Maximum working pressure adjusted to the excavator	2850 psi	2450 psi
Maximum backpressure	300 psi	100 psi
Compatibility of attachment plate with mounting bracket	HP 1800 HP 2000	HP 3000 - HP 4000 HP 5000 ÷ HP 7500

N.B. All illustrations and numerical data in this catalog are purely indicative and subject to change at our discretion and without notice. We therefore reserve the right to modify them with a view to improving and continuously developing our product.

Carrier key



Compact excavator



Miniloader



Backhoe loader



Wheeled excavator





Tracked excavator

Compatibility

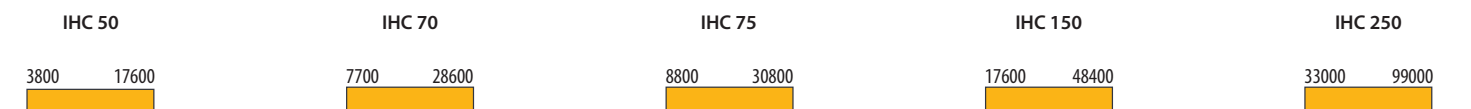

Suggested uses on machines with an overall weight (in lbs):





Technical Data	IHC R 50	IHC R 70	IHC R 75
Type of carrier	1 3	1 3 4	1 3 4
Excavator weight	7700 ÷ 28600 lbs	14300 ÷ 35200 lbs	15400 ÷ 35200 lbs
Equipment weight*	950 lbs	1400 lbs	1500 lbs
Height	34.7 in	36.7 in	36.7 in
Baseplate size	12 x 30 in	18 x 33 in	25 x 34 in
Centrifugal force	6600 lbs	8800 lbs	8800 lbs
Compacting force Min - Med - Max	10.8 16.9 24.2 psi 	11.7 15.6 20 psi 	9.2 12.2 15.7 psi 
Frequency Min - Med - Max	2000 2500 3000 rpm 33 42 50 hz	1600 1850 2100 rpm 27 31 35 hz	1600 1850 2100 rpm 27 31 35 hz
Oil flow to motor	12 ÷ 18 gpm	15 ÷ 20 gpm	15 ÷ 20 gpm
Maximum working pressure adjusted to the excavator	3450 psi	2850 psi	2850 psi
Maximum backpressure	100 psi	300 psi	300 psi
Oil delivery for rotation	3 gpm	3 gpm	3 gpm
Pressure regulated for rotation	1300 psi	1300 psi	1300 psi
Compatibility of attachment plate with mounting bracket	HP 1250	HP 1250	HP 1250

*The operating weight of the equipment includes mounting bracket compatible with Indeco construction standards. Any differences in weight may be due to a different mounting bracket configuration.

Technical Data	IHC R 150	IHC R 250
Type of carrier	4 5	4 5
Excavator weight	33000 ÷ 55000 lbs	35200 ÷ 99000 lbs
Equipment weight*	2650 lbs	3350 lbs
Height	42.6 in	43.4 in
Baseplate size	28 x 47 in	35 x 48 in
Centrifugal force	22000 lbs	37400 lbs
Compacting force Min - Med - Max	18.9 22.1 25.6 psi 	17.7 24 31.3 psi 
Frequency Min - Med - Max	1800 1950 2100 rpm 30 33 35 hz	1800 2100 2400 rpm 30 35 40 hz
Oil flow to motor	27 ÷ 32 gpm	50 ÷ 70 gpm
Maximum working pressure adjusted to the excavator	2850 psi	2450 psi
Maximum backpressure	300 psi	100 psi
Oil delivery for rotation	3 gpm	3 gpm
Pressure regulated for rotation	1300 psi	1300 psi
Compatibility of attachment plate with mounting bracket	HP 3000 HP 4000	HP 3000 HP 4000

N.B. All illustrations and numerical data in this catalog are purely indicative and subject to change at our discretion and without notice. We therefore reserve the right to modify them with a view to improving and continuously developing our product.

Carrier key



Compact excavator



Miniloader



Backhoe loader



Wheeled excavator



Tracked excavator

Compatibility

Suggested uses on machines with an overall weight (in lbs):

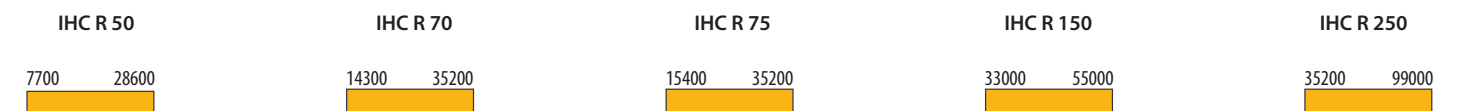

Accessories

1 | Indeconnect system

New remote monitoring system, based on the principles of the Internet of Things, to prevent equipment obsolescence and keep high performance. The 'Indeconnect' system consists of a **device** equipped with 4G technology for a wireless connection to the network, to be mounted on the equipment, and a cloud-based **web platform** you can access from mobile devices (with an app) or from PC, that lets you view the data transmitted in real time by each installed device: working hours, working position in space, hydraulic oil temperature, ambient temperature, GPS position, and more.

Through Indeconnect you can:

- **Monitor productivity**, making sure each Indeco tool is working as intended
- **Check operations**, verifying in real time the various internal and external parameters of the equipment to make sure that it is used in optimal conditions and correctly
- **Increase security**, by remotely checking the position of the equipment through GPS
- **Plan maintenance**, monitoring the health of each Indeco tool in real time, also through the automatic alert and messaging system that lets you order spare parts and reduce machine downtime to a minimum
- **Optimise rental**, by supervising and monitoring the management of rented equipment.

1 |





2 |



2 | Backfill blade

A useful option, mounted on the compactor, for smoothing and levelling the earth to be compacted, without needing to switch from compactor to bucket.

Application areas

		IHC	IHC R	
 Earth Moving and Construction	Earth moving works			
		• Trenching		
		• Ground excavation		
		• Floor leveling	○	○
		• Soil compaction	○	○
	• Trench compaction	○	○	
	• Loading soil or bulk material			
	Foundation works			
	• Building foundation excavation			
	• Ground leveling			
	Building construction			
	• Foundation pile driving	○	○	
	• Compaction around pillars	○	○	
 Infrastructures	Tunnelling			
		• Tunnel excavation		
	• Roof, face & rib scaling			
	Underwater application			
	• Dredging			
	• Dock deepening & extension			
	• Canal deepening & extension			
	• Loading soil or bulk material			
	• Handling rock or breakwaters			
	Trenching			
	• Oil & gas, water & sewage (deep trenching)			
	• Trenching			
	• Trench soil compaction	○	○	
	Road construction			
	• Pile driving and guard rail driving	○	○	
	• Asphalt repair	○	○	
	• Maintenance work (driveways, sidewalks and parking lots)	○	○	
	• Block paving	○	○	
 Agriculture and Forestry	Gardening & landscaping			
		• Fencing	○	○
		• Ground excavation		
		• Rock breaking		
		• Pit planting	○	○
		• Stump splitting		
		• Golf course maintenance		
		• Root and stump grinding		
		• Hedgerow clearance and rejuvenation		
		• Grinding of logging residues		
		Forestry		
		• Timber log handling		
		• Maintenance of green area, small trees and brush		
	• Creation and upkeep of woodland corridors and firebreaks			
	• Tree clearing			
	• Vegetation clearing			
	• Branch clearing			

The full range of other Indeco products

Products	Weight	Products	Weight	Products	Weight
IFP 8 X	1650 lbs	IHC 50	450 lbs	ISS*** 8/13	2750 lbs
IFP 13 X	2900 lbs	IHC 70	1000 lbs	ISS*** 10/20	5280 lbs
IFP 19 X	4000 lbs	IHC 75	1100 lbs	ISS*** 20/30	8030 lbs
IFP 28 X	6200 lbs	IHC 150	2150 lbs	ISS*** 25/40	10560 lbs
IFP 35 X	7600 lbs	IHC 250	2850 lbs	ISS*** 30/50	13420 lbs
IFP 45 X	10050 lbs	IHC R 50	950 lbs	ISS*** 35/60	16720 lbs
IRP 5 X	1300 lbs	IHC R 70	1400 lbs	ISS*** 45/90	22880 lbs
IRP 11 X	2550 lbs	IHC R 75	1500 lbs	IRC*** 30	9240 lbs
IRP 18 X	3750 lbs	IHC R 150	2650 lbs	IMH 3	850 lbs
IRP 23 X	5100 lbs	IHC R 250	3350 lbs	IMH 4	850 lbs
IRP 29 X	6500 lbs	IMG S** 300	630 lbs	IMH 5	1180 lbs
IRP 36 X	7950 lbs	IMG S** 400	850 lbs	IMH 6	1220 lbs
IRP 45 X	9900 lbs	IMG S** 600	1300 lbs	IMH 8	1280 lbs
IMP* 15	3300 lbs	IMG S** 1200	2550 lbs	IMH 10	1620 lbs
IMP* 20	4600 lbs	IMG S** 1700	3550 lbs	IMH 14	2310 lbs
IMP* 25	5300 lbs	IMG S** 2300	4800 lbs	IMH 20	3300 lbs
IMP* 35	7700 lbs	IMG S** 2800	5850 lbs	IMH 3.2 SS	2190 lbs
IMP* 45	9900 lbs	ISS*** 5/7	1250 lbs	IMH 4.2 SS	3090 lbs

*Crusher configuration - **Sorter configuration - ***Third-member configuration

USA Version

EN

INDECO North America

135 Research Drive
Milford CT, 06460

PH. (203) 713-1030 - F (203) 713-1040

www.indeco-breakers.com

Member of



AUTHORISED DEALER

The contents of this publication may not be reproduced in whole or in part without prior authorization from the Indeco ind S.p.a. All rights reserved.
Trademarks used in this catalog are the property of their respective holders.